

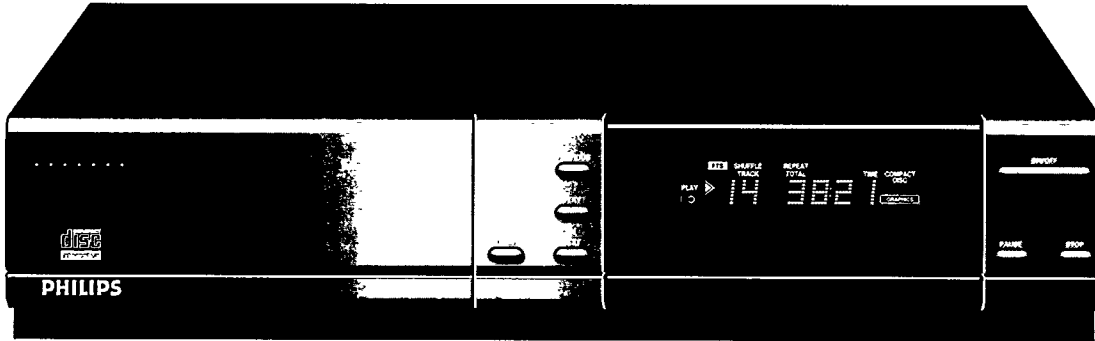

PHILIPS



CDI 220

Operating Instructions

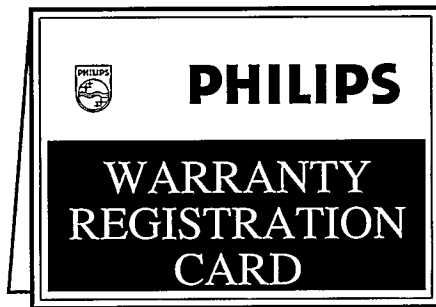

Return your Warranty Registration Card today to ensure you receive all the benefits you're entitled.

Once your PHILIPS purchase is registered, you're eligible to receive all the privileges of owning a PHILIPS product. So complete and return the Warranty Registration Card enclosed with your purchase at once. And take advantage of these important benefits.

■ Warranty Verification

Registering your product within 10 days confirms your right to maximum protection under the terms and conditions of your PHILIPS warranty.

■ Owner Confirmation

Your completed Warranty Registration Card serves as verification of ownership in the event of product theft or loss.

■ Model Registration

Returning your Warranty Registration Card right away guarantees you'll receive all the information and special offers which you qualify for as the owner of your model.

KNOW THESE SAFETY SYMBOLS.

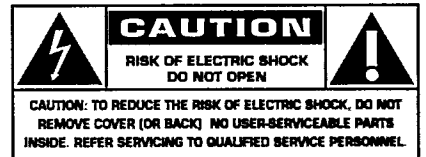

 This "bolt of lightning" indicates uninsulated material within your unit may cause an electrical shock. For the safety of everyone in your household, please do not remove product covering.

 The "exclamation point" calls attention to features for which you should read the enclosed literature closely to prevent operating and maintenance problems.

WARNING: TO PREVENT FIRE OR SHOCK HAZARD, DO NOT EXPOSE THIS EQUIPMENT TO RAIN OR MOISTURE.

CAUTION: To prevent electric shock, match wide blade of plug to wide slot, and fully insert.

ATTENTION: Pour éviter les chocs électriques, introduire la lame la plus large de la fiche dans la borne correspondante de la prise et pousser jusqu'au fond.

For Customer Use:

Enter below the Serial No. which is located on the rear of the cabinet. Retain this information for future reference.

Model No. _____

Serial No. _____



PHILIPS

Congratulations on your purchase, and welcome to the "family!"

Dear PHILIPS product owner:

Thank you for your confidence in PHILIPS. You've selected one of the best-built, best-backed products available today. And we'll do everything in our power to keep you happy with your purchase for many years to come.

As a member of the PHILIPS "family," you're entitled to protection by one of the most comprehensive warranties and outstanding service networks in the industry.

What's more, your purchase guarantees you'll receive all the information and special offers for which you qualify, plus easy access to accessories from our convenient home shopping network.

And most importantly you can count on our uncompromising commitment to your total satisfaction.

All of this is our way of saying welcome—and thanks for investing in a PHILIPS product.

Sincerely,

Robert Minkhorst
President and Chief Executive Officer

P.S. Remember, to get the most from your PHILIPS product, you must return your Warranty Registration Card within 10 days. So please mail it to us right now!

HURRY!
Registration Needed Within 10 Days.

Safety Precautions

WARNING: TO PREVENT FIRE OR SHOCK HAZARD, DO NOT EXPOSE THIS EQUIPMENT TO RAIN OR MOISTURE.

CAUTION: TO PREVENT ELECTRIC SHOCK, MATCH WIDE BLADE OF PLUG TO WIDE SLOT, FULLY INSERT.

LASER SAFETY: This unit employs a laser. Only a qualified service person should remove the cover or attempt to service this device, due to possible eye injury.

ATTENTION: POUR EVITER LES CHOCS ÉLECTRIQUE, INTRODUIRE LA LAME LA PLUS LARGE DE LA FICHE DANS LA BORNE CORRESPONDANTE DE LA PRISE ET POUSSER JUSQU'AU FOND.

CAUTION: USE OF CONTROLS OR ADJUSTMENTS OR PERFORMANCE OF PROCEDURES OTHER THAN THOSE SPECIFIED HEREIN MAY RESULT IN HAZARDOUS RADIATION EXPOSURE.

THIS DIGITAL APPARATUS DOES NOT EXCEED THE CLASS B LIMITS FOR RADIO NOISE EMISSIONS FROM DIGITAL APPARATUS AS SET OUT IN THE RADIO INTERFERENCE REGULATIONS OF THE CANADIAN DEPARTMENT OF COMMUNICATIONS.

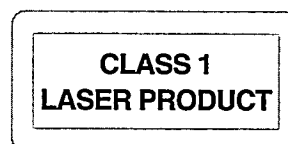

CET APPAREIL NUMÉRIQUE N'ÉMET PAS DE BRUITS RADIOÉLECTRIQUES DÉPASSANT LES LIMITES APPLICABLES DANS LA RÈGLEMENT SUR LE BROUILLAGE RADIOÉLECTRIQUES ÉDICTÉ PAR LE MINISTÈRE DES COMMUNICATIONS DU CANADA.

NOTICE: This device incorporates an anticopy process technology that is protected by U.S. patents and other intellectual property rights. The anticopy process is licensed for non-commercial, home use only. Reverse engineering or disassembly is prohibited.

WARNING:

This device complies with Part 15 of the FCC (U.S.A.) Rules. Operation is subject to the following two conditions: (1) this device may not cause harmful interference, and (2) this device must accept any interference received, including interference that may cause undesired operation.

NOTE:

This equipment has been tested and found to comply with the limits for a Class B digital device, pursuant to Part 15 of the FCC Rules. These limits are designed to provide reasonable protection against harmful interference in a residential installation! This equipment generates, uses and can radiate radio frequency energy and, if not installed and used in accordance with the instructions, may cause harmful interference to radio communications. However, there is no guarantee that interference will not occur in a particular installation. If this equipment does cause harmful interference to radio or television reception, which can be determined by turning the equipment off and on, the user is encouraged to try to correct the interference by one or more of the following measures:

- Reorient or relocate the receiving antenna.
- Increase the separation between the equipment and receiver.
- Connect the equipment into an outlet on a circuit different from that to which the receiver is connected.
- Consult the dealer or an experienced radio/TV technician for help.

IMPORTANT:

This product was FCC certified under test conditions that included use of shielded cables and connectors between system components. It is important that you use shielded cables to reduce the possibility of causing interference to radios, television sets, and other electronic devices. If you have any problems, contact your dealer.

Any change or modifications to the equipment by the user not expressly approved by the grantee or manufacturer could void the user's authority to operate such equipment.

NOTE TO CATV SYSTEM INSTALLER:

This reminder is provided to call the CATV (Cable-TV) system installer's attention to Article 820-40 of the NEC that provides guidelines for proper grounding and, in particular, specifies that the cable ground shall be connected to the grounding system of the building, as close to the point of cable entry as practical.

IMPORTANT SAFETY INSTRUCTIONS

1. Read Instructions - All the safety and operating instructions should be read before the appliance is operated.
2. Retain Instructions - The safety and operating instructions should be retained for future reference.
3. Heed Warnings - All warnings on the appliance and in the operating instructions should be adhered to.
4. Follow Instructions - All operating and use instructions should be followed.

5. Cleaning - Unplug this product from the wall outlet before cleaning. Do not use liquid cleaners or aerosol cleaners. Use a damp cloth for cleaning.

Exception: A product that is meant for uninterrupted service and that for some specific reason, such as the possibility of the loss of an authorization code for a CATV converter, is not intended to be unplugged by the user for cleaning or any other purpose, may exclude the reference to unplugging the appliance in the cleaning description otherwise required in item 5.

6. Attachments - Do not use attachments not recommended by the video product manufacturer as they may cause hazards.

7. Water and Moisture - Do not use this video product near water - for example, near a bath tub, wash bowl, kitchen sink, or laundry tub, in a wet basement, or near a swimming pool, and the like.

8. Accessories - Do not place this video product on an unstable cart, stand, tripod, bracket, or table. The video product may fall, causing serious injury to a child or adult, and serious damage to the appliance. Use only with a cart, stand, tripod, bracket, or table recommended by the manufacturer, or sold with the video product. Any mounting of the appliance should follow the manufacturer's instructions, and should use a mounting accessory recommended by the manufacturer.

8A.  An appliance and cart combination should be moved with care. Quick stops, excessive force, and uneven surfaces may cause the appliance and cart combination to overturn.

9. Ventilation - Slots and openings in the cabinet are provided for ventilation and to ensure reliable operation of the video product and to protect it from overheating, and these openings must not be blocked or covered. The openings should never be blocked by placing the video product on a bed, sofa, rug, or other similar surface. This video product should never be placed near or over a radiator or heat register. This video product should not be placed in a built-in installation such as a bookcase or rack unless proper ventilation is provided or the manufacturer's instructions have been adhered to.

10. Power Sources - This video product should be operated only from the type of power source indicated on the marking label. If you are not sure of the type of power supply to your home, consult your appliance dealer or local power company. For video products intended to operate from battery power, or other sources, refer to the operating instructions.

11. Grounding or Polarization - This video product is equipped with a  polarized alternating-current line plug (a plug having one blade wider than the other). This plug will fit into the power outlet in only one way. This is a safety feature. If you are unable to insert the plug fully into the outlet, try reversing the plug. If the plug should still fail to fit, contact your electrician to replace your obsolete outlet. Do not defeat the safety purpose of the polarized plug.

12. Power-Cord Protection - Power-Supply cords should be routed so that they are not likely to be walked on or pinched by items placed upon or against them, paying particular attention to cords at plugs, convenience receptacles, and the point where they exit from the appliance.

13. Protective Attachment Plug - The appliance is equipped with an attachment plug with overload protection. This is a safety feature. See Instruction Manual for replacement or resetting of protective device. If replacement of the plug is required, be sure the service technician has used a replacement plug specified by the manufacturer that has the same overload protection as the original plug.

14. Outdoor Antenna Grounding - If an outside antenna or cable system is connected to the video product, be sure the antenna or cable system is grounded so as to provide some protection against voltage surges and built-up static charges.

Section 810 of the National Electrical Code, ANSI/NFPA 70, provides information with regard to proper grounding of the mast and supporting structure, grounding of the lead-in wire to an antenna discharge unit, size of grounding conductors, location of antenna-discharge unit, connection to grounding electrodes, and requirements for the grounding electrode. See Fig.A.

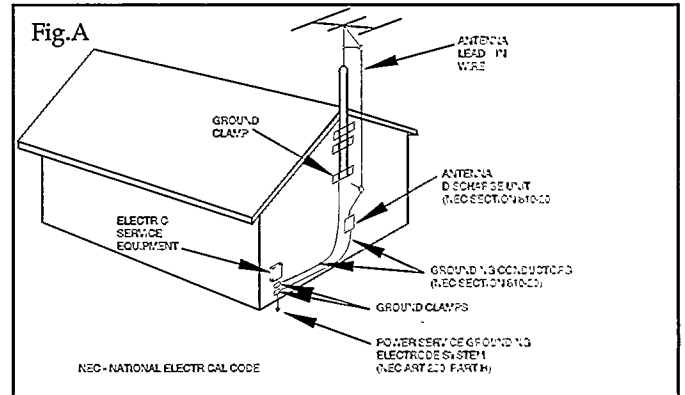

15. Lightning - For added protection for this product during a lightning storm, or when it is left unattended and unused for long periods of time, unplug it from the wall outlet and disconnect the antenna or cable system. This will prevent damage to the product due to lightning and powerline surges.

16. Power lines - An outside antenna system should not be located in the vicinity of overhead power lines or other electric light or power circuits, or where it can fall into such power lines or circuits. When installing an outside antenna system, extreme care should be taken to keep from touching such power lines or circuits as contact with them might be fatal.

17. Overloading - Do not overload wall outlets and extension cords as this can result in a risk of fire or electric shock.

18. Object and Liquid Entry - Never push objects of any kind into this product through openings as they may touch dangerous voltage points or short-out parts that could result in a fire or electric shock. Never spill liquid of any kind on the product.

19. Servicing - Do not attempt to service this product yourself, as opening or removing covers may expose you to dangerous voltage or other hazards. Refer all servicing to qualified service personnel.

20. Damage Requiring Service - Unplug this product from the wall outlet and refer servicing to qualified service personnel under the following conditions

- a. When the power-supply cord or plug is damaged.
- b. If liquid has been spilled, or objects have fallen into the product.
- c. If the product has been exposed to rain or water.
- d. If the product does not operate normally by following the operating instructions. Adjust only those controls that are covered by the operating instructions as an improper adjustment of other controls may result in damage and will often require extensive work by a qualified technician to restore the product to its normal operation.
- e. If the product has been dropped or the cabinet has been damaged.
- f. When the product exhibits a distinct change in performance - this indicates a need for service.

21. Replacement Parts - When replacement parts are required, be sure the service technician has used replacement parts specified by the manufacturer or which have the same characteristics as the original part. Unauthorized substitutions may result in fire, electric shock or other hazards.

22. Safety Check - Upon completion of any service or repairs to this product, ask the service technician to perform safety checks to determine that the product is in proper operating condition.

23. Carts and Stands - The appliance should be used only with a cart or stand that is recommended by the manufacturer.

24. Heat - The product should be situated away from heat sources such as radiators, heat registers, stoves, or other products that produce heat.

LIMITED WARRANTY CD-i

- One (1) Year Free Labor • One (1) Year Free Parts Service
- This CD-i must be shipped in for warranty service.

Please keep...

...your sales receipt and other material proving proof-of-purchase. Attach it to this owner's manual and keep it nearby. Please also keep the original box and packing material should you ever need to ship your CD-i player to Philips for service.

One (1) Year Coverage...

...starts from the date you bought your product. Both parts and labor are covered at no cost to you. Any defective part will be repaired or replaced. Any part is covered only for the original warranty period. Once the one (1) year warranty on the product has expired, the warranty on any replaced or repaired part also expires. Service for your CD-i is provided by shipping it to the Philips Factory Service Center (listed to the right) which specializes in this type of product.

After one year, you must pay for all labor, parts, transportation, and service charges.

Who is Protected? ... Where?

Only the person who has proof-of-purchase will receive warranty service. This service will be provided to any product bought and used in the U.S.A., Puerto Rico, the Virgin Islands and Canada. If you move within these areas you must ship your monitor to the designated Philips Factory Service Center listed in this warranty.

Before Calling for Service...

...please check your owner's manual. A check of the controls discussed there may save you a service call.

How To Get Warranty Service

Due to the sophisticated nature of this product, warranty service will be provided by the Philips Personal Information Products Answer Center. If you feel you require warranty service for or need to discuss a problem about your CD-i, please contact the Philips Personal Information Products Answer Center at (800) 845-7301. There, a technician will go through a diagnostic check list with you and if it is determined the unit needs to be repaired, you will be given a return authorization number. Carefully pack the CD-i in secure packaging for safe shipment. It is recommended that you retain the carton and all packing materials from this unit. These materials are specifically designed and manufactured for shipping this product. Deliver or ship it freight prepaid and insured to the Philips Factory Service Center listed, with evidence of the purchase date and description of the problem. Following warranty repair, the unit will be returned to you freight prepaid. Be sure you include your complete return address on the outside of the carton.

Warranty Exclusions - Your Warranty Does Not Cover...

...replacing or repairing your product because of misuse, accident, unauthorized repair, or other cause not within the control of Philips Consumer Electronics Company.

...incidental or consequential damages resulting from the product. Some states do not allow the exclusion of incidental damages, so the above exclusion may not apply to you.

...labor charges for installation or set-up, adjustment of customer or preference controls, and installation or repair of antenna systems outside the product.

...a product bought, used, or serviced outside the U.S.A., Puerto Rico, the Virgin Islands, and Canada.

...problems caused by signal or cable conditions outside the product.

For product purchased in the U.S.A., Puerto Rico, or the Virgin Islands

How To Get Warranty Service:

If warranty service is required, you must ship your product with proof-of-purchase to a Philips Factory Service Center (listed below.)

Philips Factory Service
5164 Blazer Parkway
Dublin, OH 43017
(614) 792-1495

IN THE U.S.A., PUERTO RICO, OR THE VIRGIN ISLANDS, ALL IMPLIED WARRANTIES INCLUDING IMPLIED WARRANTIES OF MERCHANTABILITY AND FITNESS FOR A PARTICULAR PURPOSE, ARE LIMITED IN DURATION TO THE DURATION OF THIS EXPRESS WARRANTY. Some states do not allow limitations on how long an implied warranty lasts, so the above limitation may not apply to you. This warranty gives you specific legal rights, and you may have other rights which vary from state to state.

Philips Service Company
P.I.P. Information Center
(800) 835-3506

For product purchased in Canada

How To Get Warranty Service:

To obtain warranty service, the product must be delivered (carried-in) to a Philips Consumer Service Branch (listed below). These warranties are given in lieu of all other warranties. No other guarantees or warranties are expressed or implied, including any implied warranties of merchantability or fitness for a particular purpose. Philips shall not be liable under any circumstances for any direct, indirect, special, incidental or consequential damages, howsoever incurred, even if notified of the possibility of same. All that's required to validate your original factory warranty is to present your bill of sale as proof of purchase.

Philips Electronics Ltd.
601 Milner Avenue • Scarborough, Ontario M1B 1M8 •
(416) 292-5161 5930 Côte de Liesse • Montréal, Québec
H4T 1E1 • (514) 342-9180 3695 Grandview Hwy. •
Vancouver, B.C. V5M 2G7 • (604) 435-4411

IMPORTANT REMINDER:

Please fill out and mail your warranty registration card promptly. It will be easier for us to notify you if it should ever be required. Please also keep your sales receipt and other proof-of-purchase information.

Please write in your model and serial numbers below. These numbers are located on your unit. Keep this manual nearby for easy reference.

Model No.: CDI 220

Serial No.:

CONTENTS	7
INTRODUCTION - INSTALLATION	8
INSTALLATION	9-12
POINTING DEVICE	13
SETTING UP	14
PLAYING DISCS	15-17
BEFORE REQUESTING SERVICE	18
GLOSSARY	19
NOTES	20-22
SPECIFICATIONS	23
ACCESSORIES	24

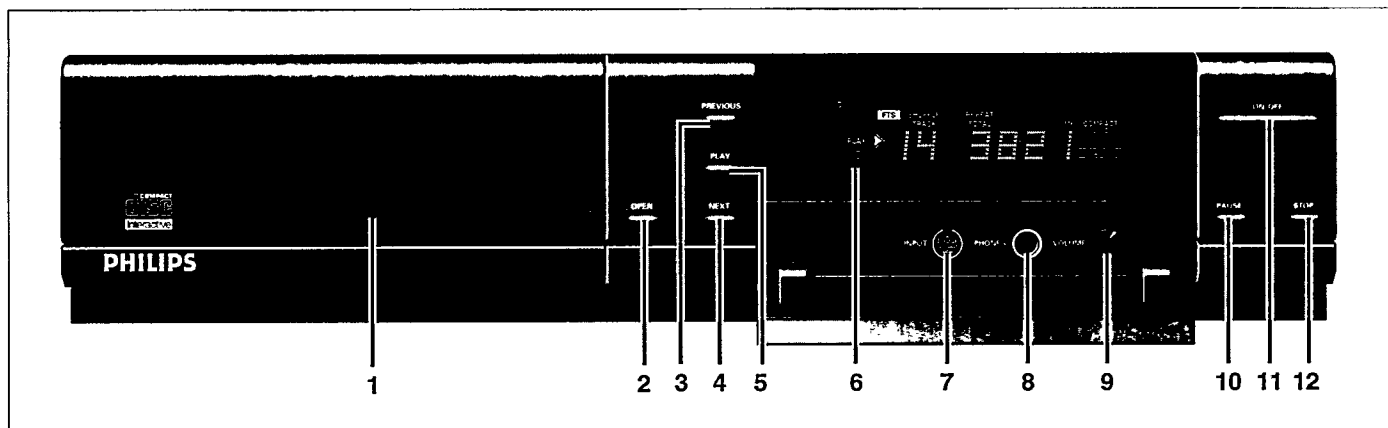

INTRODUCTION

We are pleased to introduce to you one of the most innovative products available today: the Compact Disc Interactive player. You'll be surprised how easy it is! Once correctly hooked up to your TV, you simply 'point-and-click' to explore the intriguing new world of interactive Compact Disc.

Your CD-i player also plays CD-DA (audio compact discs) and Audio tracks from CD-ROM discs. In addition it can play also the following disc types: Photo CD, CD-i Ready, CD Bridge, and CD Graphics (CD+G).

By simply plugging in the optional Digital Video Cartridge, you can upgrade the player to run interactive Digital Video titles including movies, music videos and high-power action games as well as Video CD's.

A wide variety of optional accessories enhances the player's flexibility. Contact your authorized dealer for more information.

We are confident that you will find this product surprisingly easy to use, and quite unique in its fascination.

FRONT OF PLAYER

- 1 Disc loading tray.
- 2 Open/close button.
- 3 Previous track selection button.
- 4 Next track selection button.
- 5 Play button.
- 6 Soft tone multifunction display with infra-red remote control receiver.
- 7 Input port for CD-i pointing devices.
- 8 Headphone jack.
- 9 Headphone volume control.
- 10 Pause button.
- 11 AC power on/off button.
- 12 Stop button.

DISPLAY

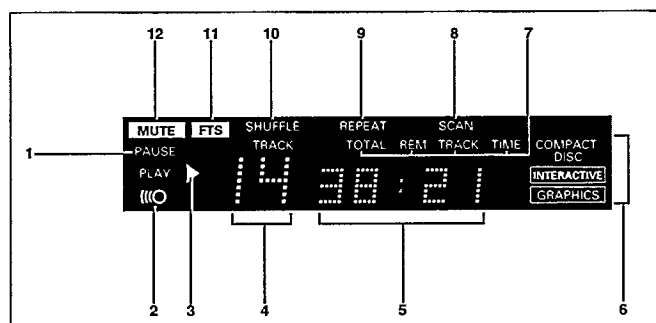

- 1 CD pause active.
- 2 Remote control active (flashing indicator).
- 3 Disc playing (stepping indicator).
- 4 Track number (CD-Audio).
- 5 Elapsed or remaining time (CD-Audio).
- 6 Type of disc indicator.
- 7 Time indicators.
- 8 CD scan active.
- 9 CD repeat active.
- 10 CD shuffle active.
- 11 CD FTS active.
- 12 Mute indicator.

REMOTE CONTROL

- 1 Infra red remote transmitter.
- 2 Action button.
- 3 Thumbpad.
- 4 Action buttons (for left or right handed operation).
- 5 Sliding Cover.
- 6 Play button.
- 7 Pause button (CD-Audio + Video CD).
- 8 Stop button (CD-Audio + Video CD).
- 9 Volume control up button.
- 10 Volume control down button.
- 11 CD-i/TV button.
- 12 Next track button (CD-Audio + Video CD).
- 13 Previous track button (CD-Audio + Video CD).
- 14 Standby*

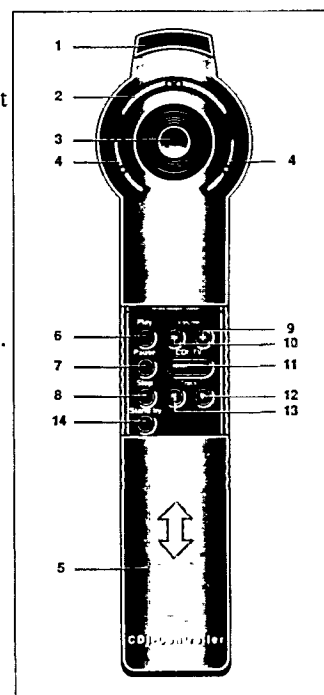

* Available on some player versions only. Not functional for CD-I 210/220.

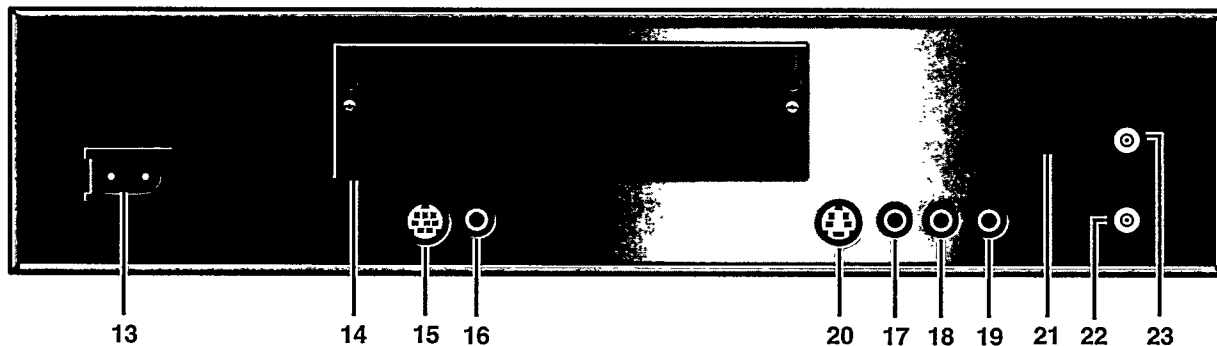

PLACEMENT

- Place the player on a firm flat surface.
- Keep away from heat sources and direct sunlight.
- In a cabinet, allow 2-3 cm (approx. 1 inch) of free space all around the unit for adequate ventilation.

REAR OF PLAYER

- 13 AC power (alternating current) input socket.
 - 14 Extension socket for 22 ER 9956.
 - 15 Input port for CD-i serial connections (not for pointing devices).
 - 16 Digital out.
 - 17 Audio output R.
 - 18 Audio output L.
 - 19 Video output (CVBS).
 - 20 Y/C (S-video) output.
 - 21 Channel selector.
 - 22 RF OUT.
 - 23 TV antenna input.
- If you require any optional connection accessories, contact your authorized dealer.

POWER CONNECTION

- Check that the power voltage indicated at the player matches the voltage of the AC outlet.
- Connect the female end of the AC (alternating current) cord supplied into the AC socket (13).
- Insert the male end of the cord into an AC outlet.

CAUTION

NEVER MAKE OR CHANGE CONNECTIONS (OTHER THAN THE HEADPHONES) WITH THE POWER SWITCHED ON.

ONLY A QUALIFIED SERVICE TECHNICIAN SHOULD REMOVE THE COVER OR ATTEMPT TO SERVICE THIS DEVICE.

USE OF CONTROLS OR ADJUSTMENTS OTHER THAN THOSE SPECIFIED HEREIN MAY RESULT IN HAZARDOUS RADIATION EXPOSURE OR OTHER UNSAFE OPERATION.

THE PLAYER AUTOMATICALLY ADJUSTS TO THE LOCAL POWER VOLTAGE.

WHEN THE PLAYER IS IN THE "OFF" POSITION, IT IS STILL CONSUMING SOME POWER. IF YOU WISH TO DISCONNECT YOUR PLAYER COMPLETELY FROM THE POWER, THE POWER PLUG HAS TO BE DISCONNECTED.

INSTALLATION

1. CHOOSING THE RIGHT CONNECTIONS

Most of today's TV receivers have several picture input connections. In order of picture quality, these are:

- S-Video (or Y/C);
- Video (CVBS);
- Antenna in.

Depending on the version of your player it is advised to connect it to the TV input with the highest quality picture.

NOTE

- Please refer to the instructions that come with the TV set for selection of the correct input.

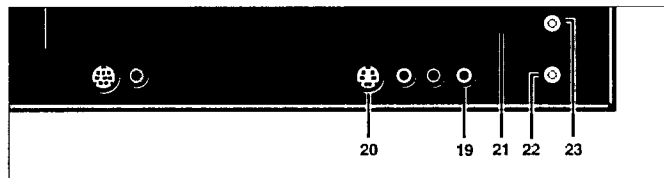

- 19 Video output (CVBS).
- 20 Y/C (S-video) output.
- 23 TV antenna input.

2. CONNECTION TO A TV WITH AN Y/C (S-VIDEO) SOCKET

- Just connect the corresponding connectors with a matching Y/C cable.
- As this Y/C cable does not connect the audio, the audio has to be connected separately.

NOTE

- Please refer to the instructions that came with the TV set for selection of the correct input.

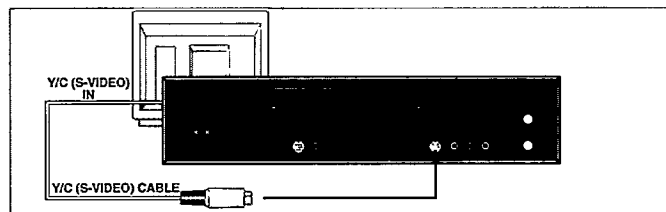

3. CONNECTION TO A TV WITH A VIDEO (CVBS) SOCKET

- Connect the corresponding connectors with a matching video cable.
- This cable does not connect the audio, and has to be connected separately.

NOTE

- Please refer to the instructions that come with the TV set for selection of the correct input.

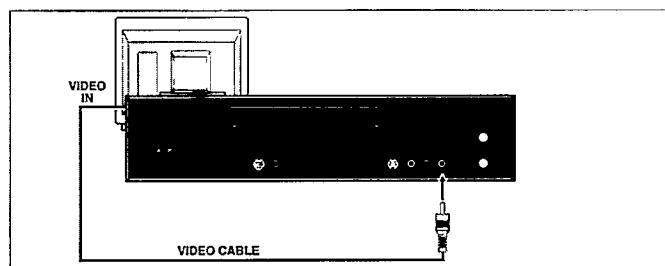

4. ANTENNA CONNECTION

- Connect the player to the TV antenna input, using a matching cable.
- If you already have a VCR (or antenna or cable) connected to the TV antenna input and your CD-i player has an antenna input, connect the CD-i player between the VCR (or antenna or cable) antenna output and the TV antenna input, you may also use an optional external switchbox, if desired.
- Your CD-i player sends pictures and sound to your TV on the channel number indicated on the rear or on the channel selector position (21) at the rear. This signal is sent through the coaxial cable.
- To operate the player with your TV, set your TV to the same channel.
- If your CD-i player has a channel selector (21), to located at the rear, you can avoid local interference by selecting to a different channel.

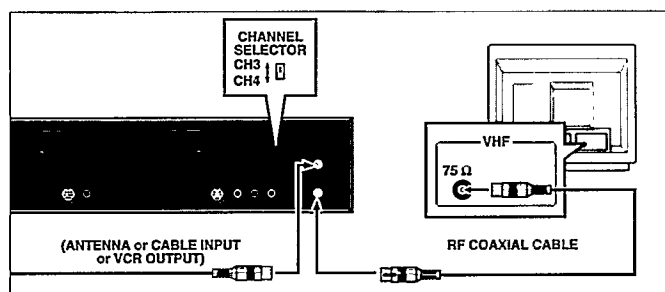

NOTE

- The sound sent through the RF output to your TV is *mono* only.
- Please refer to the instructions that come with the TV set for selection of the correct input.

5. AUDIO CONNECTIONS

- If you use the TV antenna input (23), the TV will play sound along with the picture.
- If you use the Y/C (S-video) (20) or video (CVBS) (19) input, you will also need to connect the player's audio output (17, 18) to the TV's audio input.

- For HiFi sound, you can connect the player's audio output (17, 18) to the input of your HiFi system, provided that the player, TV and HiFi system are placed close to each other.

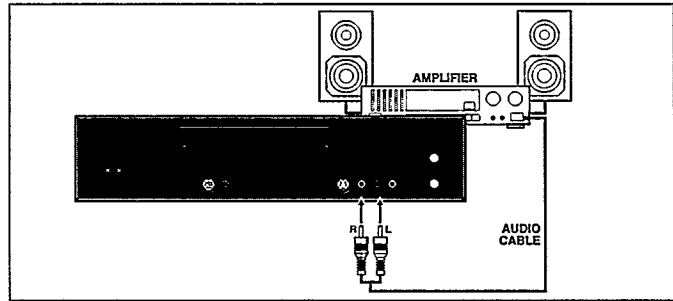
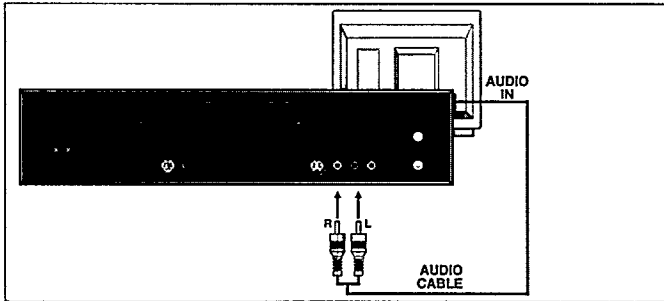

CAUTION
DO NOT CONNECT THE PLAYER'S AUDIO OUTPUT (17, 18) TO THE HIFI PHONO (RECORD PLAYER) INPUT.

- NOTE**
- Please refer to the instructions that came with the TV-set for the selection of the channel or the input used.

6. DIGITAL OUT CONNECTION

Only for audio discs.
This output supplies a digital signal and can therefore only be connected to an input which is suitable for this signal.

Never connect this socket to a non-digital input of an amplifier, such as AUX, CD, TAPE, PHONO, etc.!

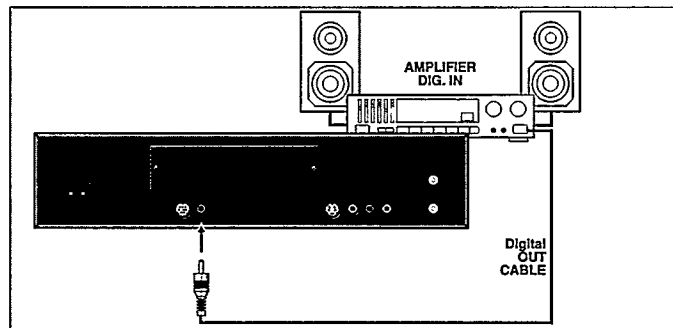

INSTALLATION

7. INSTALLING A DIGITAL VIDEO CARTRIDGE

As soon as you have plugged this cartridge into your CD-i player, you can play the latest CD-i discs, featuring interactive movies, music videos and state-of-art video games as well as video CD's. Enjoy yourself! But first.....

NOTE

- A special tool is supplied with the cartridge. Keep it safe in case you need it.

CAUTION - WHILE INSTALLING (OR REMOVING) YOUR CARTRIDGE, MAKE SURE THE PLAYER IS SWITCHED OFF!

INSTALLATION:

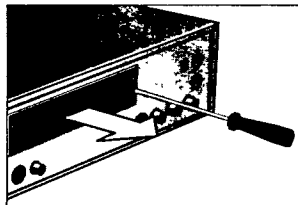

Loosen the screws and remove the coverplate.

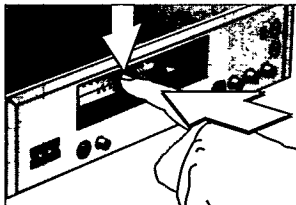

Push the bracket on the left side down.

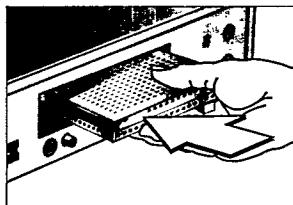

Take hold of the cartridge with connector side pointing to the right. Slide the cartridge in the slot.

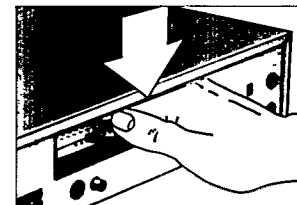

Connect the cartridge by pushing it until the bracket goes up.

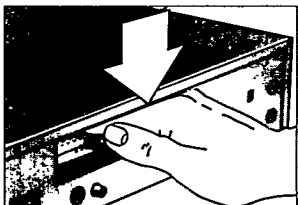

Then push the cartridge firmly as far as it will go.

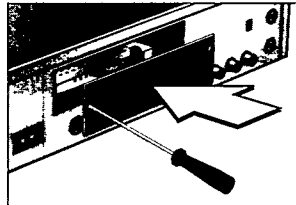

Check if the cartridge is positioned horizontally. Replace the coverplate.

THE CARTRIDGE IS NOW INSTALLED AND SHOULD NOT BE REMOVED WITHOUT CAUSE: IT CARRIES 1 MB EXTRA MEMORY WHICH IS VALUABLE EVEN FOR TITLES WITHOUT DIGITAL VIDEO (FULL-MOTION).

REMOVAL:

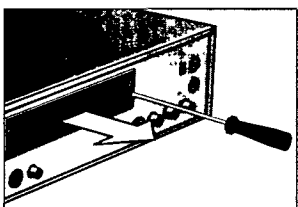

Loosen the screws and remove the coverplate.



Push the bracket on the left side down.

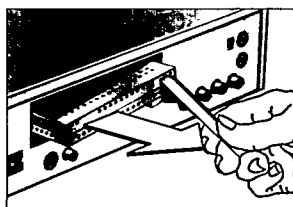

Hook the special extractor tool in the slot of the cartridge and remove the cartridge from the slot.

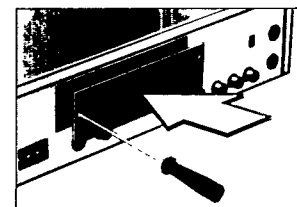

Replace the coverplate.

BEFORE REQUESTING SERVICE!

- SHOULD THE PLAYER MALFUNCTION AFTER CARTRIDGE INSERTION, TRY REMOVING AND THEN REINSERTING IT.
- DO NOT ATTEMPT REPAIRS: THIS WILL INVALIDATE THE WARRANTY.

CAUTION

- DO NOT PROBE INTO THE VENTILATION HOLES!
- DO NOT BLOCK THE VENTILATION HOLES!

PRECAUTIONS

To operate your CD-i player a pointing device is needed. For pointing devices other than the included one, please consult your supplier.

CAUTION

NEVER MAKE OR CHANGE CONNECTIONS WITH THE POWER SWITCHED ON.

Pointing devices are sensitive precision instruments. Handle them with care, keeping in mind the following precautions:

- Avoid dropping or knocking
- Do not use them in locations subject to extreme temperatures, humidity, dust, or vibration.

INFRA RED REMOTE CONTROL

Loading the batteries in the remote control

- Push and slide the battery compartment cover.
- Insert three 'AA' (R6 or SUM3) batteries as indicated inside the battery compartment.
- Replace the cover.

CAUTION

DO NOT MIX OLD AND NEW BATTERIES. ALSO NEVER MIX DIFFERENT TYPES OF BATTERIES (STANDARD, ALKALINE AND SO ON).

NOTE

- To save battery power, the remote control automatically switches off after approximately one minute if a button is pressed continuously. It is automatically reactivated the next time you press any button.

Remote control interactive operation

For normal interactive operation, use the remote control to select functions displayed on the TV screen.

- Point the remote control at your CD-i player.
- Move the cursor in the direction you want by pressing in that direction on the "Thumbpad".
 - The harder you press the faster the cursor arrow moves.
- Click on one of the action buttons.
 - The function selected by this 'point-and-click' technique is highlighted to confirm the selection.

NOTE

- To 'point-and-click' on any screen shown in this manual, any one of the action buttons can be used.
- The shape of the cursor is different according to the program you are playing, but it is always controlled in the same way.

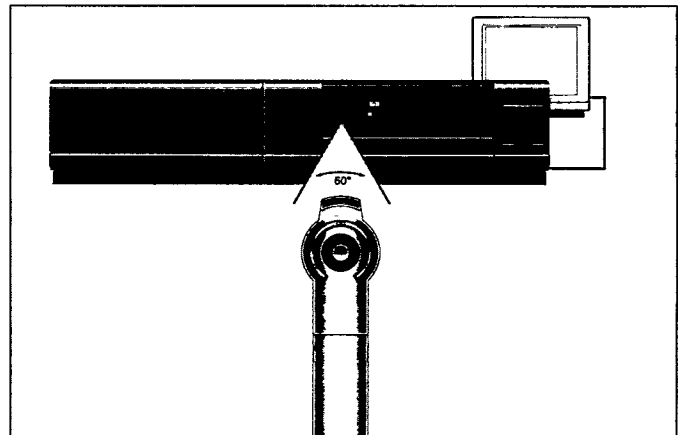
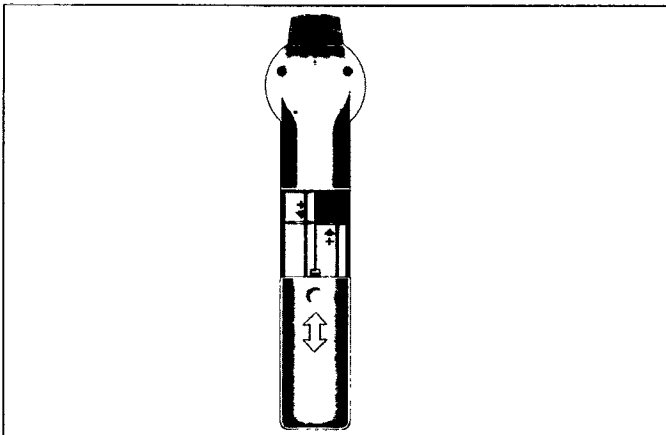

CD-i CONTROLLER

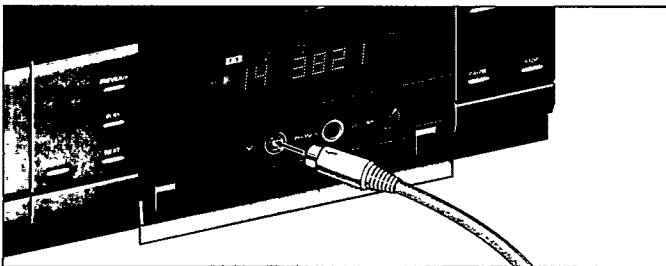

- Another way to operate your CD-i player is by using a CD-i Controller.
 - Press the ON/OFF button (11) to switch the player off.
 - Plug the connector of the CD-i controller into the input port (7). Insert the connector with the arrow at the top.
 - Switch the player on.
 - Move the cursor in the direction you want
 - Click on one of the action buttons.
- The function selected by this "point-and-click" technique is highlighted to confirm the selection.

CAUTION

NEVER MAKE OR CHANGE CONNECTIONS WITH THE POWER SWITCHED ON.

NOTE

- When simultaneous use of two pointing devices is required by the CD-i title, the optional accessory 22ER9208 (I/O Port Splitter) has to be used to connect these devices to Input (7).
- Optional devices are: Roller Controller, Trackerball, Mouse, Touchpad, Gamepad, Thumbpad (refer to the accessories p. 24).
- To "point-and-click" on any screen shown in this manual, either one of the action buttons of the pointing device can be used.
- The shape of the cursor can be different depending on to the program you are playing, but it is always controlled in the same way.
- Pointing devices are sensitive precision instruments. Handle them with care, keeping in mind the following precautions:
 - Avoid dropping or knocking.
 - Do not use them in locations subject to extreme temperatures, humidity, dust or vibration.
 - Never hold the pointing device by the cable.
 - Never pull the cable to disconnect the pointing device from the player.

SETTING UP

SWITCHING ON AND OFF

- Press the ON/OFF button **(11)** to switch the player on.
- Switch on the TV (and HiFi system if used).
- Select the input on the TV (and HiFi system if used).
- On the TV, the player start-up screen will appear. This screen has the following system function icons to guide and assist you:

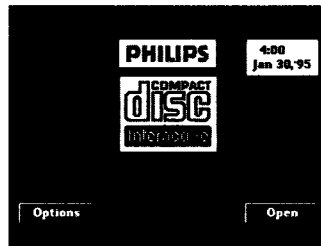

Open/Close:

To open or close the disc tray.

Options:

See: 'OPTIONS SCREENS'.

To get "OPTIONS SCREENS" click on "OPTIONS". To leave "OPTIONS SCREENS" click on "EXIT".

- Press the ON/OFF button **(11)** to switch the player off.
- Switch off the TV (and HiFi system, if used).

OPTIONS SCREENS

1. CD Audio Options

To preselect your preferred settings when playing audio CDs:

Auto shuffle

When the player is switched on, the tracks on the CD will automatically be played in a random order.

Auto FTS

When the player is switched on, the FTS program of the CD will be played automatically

Repeat

Select to repeat a complete audio disc or a single track when the repeat function is activated.

Scan time

Select the time you want the beginning of each audio track to play for (5, 10 or 20 seconds) when the scan function is activated.

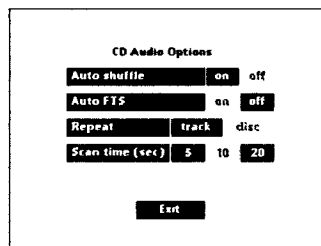

3. Time and Date Options

To change the player time/date settings:

Time/Date set

If the time or date shown on the screen is wrong, select the appropriate ▲ and ▼ arrows to set hours, minutes, day, month and year, as required.

Time format

Select 24 hour or 12 hour clock.

Date format

Select d/m/y to present the date in day-month-year sequence. Select m/d/y to present the date in month-day-year sequence.

Display time/date

Select whether time and date will be displayed on the TV screen or not.

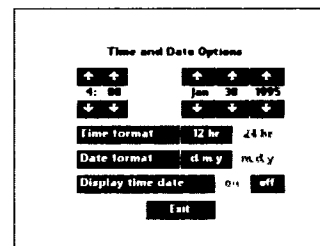

2. General Options

To change the player general settings:

Auto play

When the player is switched on, playback will start automatically when a disc is loaded and the tray is closed.

Volume

Selecting the player default volume setting.

16 : 9 screen display

Selecting 16 : 9 screen display, when you have your player connected to a TV with a 16 : 9 screen.

Positioning video

If the player is connected to the TV set via the A/V euroconnector cable (blue euroconnector on TV set; RGB signal) the actual video position on the TV screen is TV set dependent. Activate the positioning button ← or → to optimally center the playershell image on the TV screen.

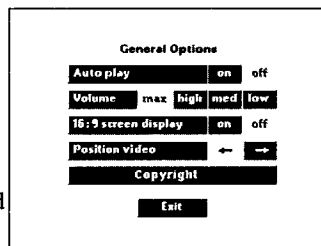

4. Storage Options

To refer to the intermediate results of CD-i titles and the programs created for your audio and Photo CDs.

The 'Storage' screen shows the information held in memory: titles, dates and percentage of memory used.

Clicking on 'Name', 'Date' or 'Size' sorts the information accordingly.

- Use the scroll arrows to move up and down the list.
- To delete an item, click on its title and then click on 'Delete'. If you change your mind after deleting, click on 'Undo'.

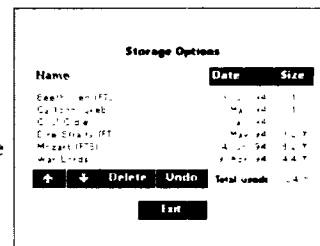

GENERAL

Push button control:

- For basic play control, or for playing discs through a stereo system without using the TV, you can use the buttons on the front panel or on the remote control.
- The PLAY and STOP buttons operate in the same way as the corresponding on-screen functions.
- The NEXT and PREVIOUS buttons skip one track forward or backward respectively.

NOTE

- The functioning of these buttons will depend completely on the application when playing a CD-i program.

Changing over to TV:

- Select the desired channel or input of your TV using the controls of your TV set.
- When the player is switched on, its antenna signal is fed through to the TV and depending on the player-TV connection, TV reception might be interrupted automatically.
- To change over to TV reception at any time in such case, press the CD-i/TV button (11) on the remote control
- To return to CD-i play, press the CD-i/TV button (11) again.

Sound level:

- When playing any disc adjust the sound level as required, preferably on the TV or HiFi amplifier.
- The volume up (9)/down (10) buttons on the remote control may also be used, but for each disc these controls always start at the level set in the General Options Screens. A suitable level must therefore first be set on the TV or HiFi amplifier.

LOADING AND UNLOADING

Loading:

- Point and click on 'Open' (you may also press the OPEN /CLOSE button (2) on the player) to open the disc tray (1).
- Take the disc from its holder and place it on the tray with the label up.
- Point and click on 'Close' (you may also press the OPEN/CLOSE button (2) on the player, or gently push the front of the tray) to close the tray.

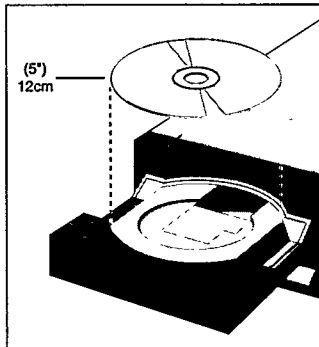

- The TV screen changes according to the type of disc.

Unloading:

- Point and click on 'Open' (you may also press the OPEN /CLOSE button (2) to open the disc loading tray).
- The player start-up screen reappears on the TV.
- Take the disc from the tray and replace it in its holder.
- Point and click on 'Close' (you may also press the OPEN/CLOSE button (2) on the player, or gently press the front of the tray) to close the tray with or without a new disc.

NOTE

- You may unload the disc at any time by pressing the OPEN/CLOSE button (2).
- Unloading a CD-i disc while the CD-i program is running, will terminate the CD-i program abruptly. 'Bookmarks' or intermediate results, if used by the CD-i program, might not be updated to the latest situation.

CAUTION

NEVER PUT MORE THAN ONE DISC AT A TIME INTO THE CD-i PLAYER

PLAYING A CD-i DISC

Playing a CD-i disc depends on the value of Autoplay (see Options Screens). The factory setting is default "OFF".

1. When autoplay is "OFF":
After the disc is loaded, the CD-i start-up screen appears on the TV. To start the CD-i program, select 'Play' and click on it.
2. When autoplay is "ON":
After the disc is loaded, the CD-i program will start up automatically.

The opening screen of the CD-i program now appears on the TV. From this point, all interaction is between you and the program. To stop at any time, select the STOP or EXIT function provided by the CD-i program.

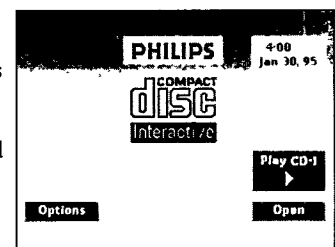

NOTE

- This procedure applies equally to CD BRIDGE discs, CD-i READY discs and PHOTO CDs. And for Digital Video discs and Video CD's when a Digital Video Cartridge has been installed.

CAUTION

NEVER LEAVE A STILL PICTURE ON THE SCREEN FOR ANY LENGTH OF TIME. THIS CAN CAUSE BURNING-IN OF THE PICTURE TUBE. IN SUCH A CASE SWITCH OFF THE PLAYER OR REMOVE THE DISC.

– After the disc is loaded, the CD-Audio screen appears on the TV.

1. Play track bar:

Shows all the track numbers (up to 30). You can 'point-and-click' to select any track. For discs with more than 30 tracks, use the right > and left < scroll arrows to move through the track list.

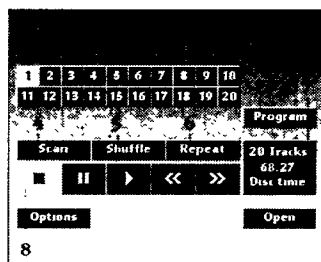

2. PROGRAM: Allows you to program a list of special tracks called a Favorite Track Selection. When you select PROGRAM, the FTS track bar and the FTS icon will appear.

3. FTS: Allows you to play Favorite Track Selections. This icon only appears if a Favorite Track Selection has been created for the disc that is loaded in the player.

4. SCAN: Allows you to listen to the beginning of every track listed in the play track bar. You can set the scan time to 5, 10 or 20 seconds in the 'Options' screen p.14.

5. SHUFFLE: Allows you to play the tracks in the play track bar in a random order.

6. REPEAT: Allows you to repeat either a track or the entire disc. You can change the repeat mode in the 'Options' screen p.14.

7. TRACK/TIME window:

– In STOP mode, this shows the total number of tracks and the total playing time. When you click at this window (7), the track time of the selected track is displayed.

– In PLAY and PAUSE modes, the window shows the track number and either the elapsed or the remaining track playing time. To change between elapsed and remaining time, 'point-and-click' at the time shown in the window.

8. All the disc play control functions are shown on the screen, and can be selected as desired by 'point-and-click' with your remote control. The operation of the functions is briefly explained in the following table.

NOTE

– If auto SHUFFLE or auto FTS has been selected on the 'CD Audio' screen, this function will be activated automatically.

OPERATION	SELECT
Start play	PLAY ▶ play starts at the beginning of track 1, or any other preselected track number. If a track is already playing, it is re-started.
Select a track	TRACK number ◀▶ if the disc contains more than 30 tracks, use the left < and right > scroll arrows to move through the track numbers as required.
Pause	PAUSE II interrupts play (Toggle effect).
Exit pause	PAUSE II or PLAY ▶ play restarts at exactly the same point as pause was selected.
Forward search	FORWARD ▶▶ searches forward through disc.
Reverse search	REVERSE ◀◀ searches backwards through disc.
Stop play	STOP ■ stops playing. If play is re-started, it begins at the first track.
Scan the disc	SCAN plays the beginning of each track listed in the play track bar.
Exit scan	SCAN normal play starts from this point.
Shuffle play	SHUFFLE shuffle sequence appears in track bar.
Exit shuffle	SHUFFLE normal play starts from this point.
Repeat	REPEAT repeats the entire disc (or FTS program), or the track being played, as selected on the "Options" screen.
Play FTS	FTS only available when an FTS program has already been created for the disc in the player.
Exit FTS	EXIT FTS normal play starts from this point.
Program FTS	PROGRAM <ul style="list-style-type: none"> • Point to tracks as required on the play track bar, and in each case click on an action button to enter the track in the FTS track bar. • To cancel an unwanted track, point to it in the FTS track bar and click on an action button. • To cancel the entire FTS program, point to the first track in the FTS track bar and click on an action button repeatedly until all the tracks disappear.
Store FTS	SAVE FTS the keyboard screen replaces the CD-Audio screen. See 'CREATING FTS TITLES' p.17.

PLAYING AN AUDIO CD

2. Creating FTS titles

- At the CD-Audio screen (p.16), 'point-and-click' on the Program button, then 'point-and-click' on the "Save FTS" button.
- The keyboard screen will appear.
- Select each character of the title in turn, using Shift to change between upper and lower case characters and Space to separate words.
- Delete erases the last selected character.
- Clear erases the complete (or partially complete) title.
- Cancel returns to the CD-Audio screen without saving the title.
- Save saves the title and returns to the CD-Audio screen.

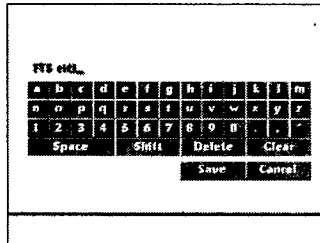

- Using the keyboard screen, you can compose a title of approximately 30 characters (depending on the character width) for the selection
- After creating an FTS, the title then appears on the CD-Audio screen whenever the disc is loaded.

PLAYING AN AUDIO CD

3. CD graphics

- When an audio CD with graphics is played, the CD Graphics screen will appear automatically.
- To make the picture channel bar appear/disappear click on the action button anywhere outside the channel bar.
- You can select another track number by clicking on 'Track' or either arrow next to it.
- Depending on the disc, other channel numbers might give you other information, such as the lyrics in a different language.
- For information about the actual graphics functions, refer to the instructions that come with the disc.
- To play audio only, click on 'Audio'.

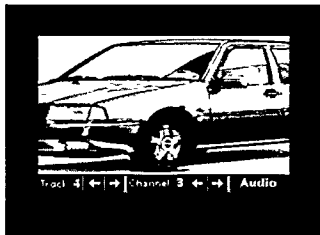

CAUTION

NEVER LEAVE A STILL PICTURE ON THE SCREEN FOR ANY LENGTH OF TIME. THIS CAN CAUSE BURNING-IN OF THE PICTURE TUBE. IN SUCH A CASE SWITCH OFF THE PLAYER OR REMOVE THE DISC.

PLAYING A PHOTO CD

- After loading the disc, the CD-i start-up screen appears on the TV.
- To start the Photo CD program, select the 'PLAY CD-i'; you may also press the PLAY button (5) on the player or remote control (6).
- The opening screen of the Photo CD program now appears on the TV.
- At the bottom of this screen a menu bar with icons is shown.

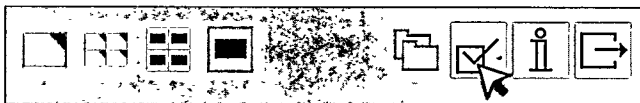

- Select the icon.
- The 'Options' screen will now appear.
- To select a language click on the box, the flag or the name of a country.
- The previous setting will be replaced automatically.

- Select the icon (Return) of this screen to go back to the Photo CD opening screen.

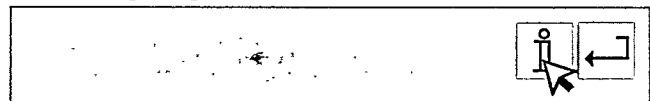

- Select the icon (Information) and the INFORMATION screen, explaining the control buttons of the menu bar in the selected language, appears.
- From this point, all interaction is between you and the program.

CAUTION

NEVER LEAVE A STILL PICTURE ON THE SCREEN FOR ANY LENGTH OF TIME. THIS CAN CAUSE BURNING-IN OF THE PICTURE TUBE. IN SUCH A CASE SWITCH OFF THE PLAYER OR REMOVE THE DISC.

BEFORE REQUESTING SERVICE

If it appears that the CD-i player is having problems, first consult this check-list. It may be that something simple has been overlooked.

Under no circumstances attempt to repair the player yourself; this will invalidate the warranty.

- No power** • Check that the ON/OFF button (**11**) is set to on.
• Check that both plugs on the power cord are properly connected.
• Check that there is power at the AC outlet by plugging in another appliance.
- No picture**..... • Check that the TV is switched on.
• Select the same channel or input on the TV as that of the player.
• Check the video connection.
- Distorted picture**..... • Check the disc for fingerprints and clean with a soft cloth, wiping from centre to edge.
- No open icon on TV screen** • Switch the player off, then switch on again while holding the STOP button (**12**) pressed.
- No start-up. Screen does not change** • Check the disc label is upwards.
• Clean the disc.
• Check if the disc is defective by trying another disc.
- No sound**..... • Check audio connections.
• If using a HiFi amplifier, try another sound source.
- Distorted sound from HiFi amplifier** • Check that audio connections are not made to amplifier Phono input.
- No return to start-up screen when disc is removed**..... • Reset by switching the player off, then on again.
• Check if the CD-i program requires another disc to be loaded.
- The player can't be remote controlled**..... • Aim the remote control directly at the sensor on the player.
• Avoid all obstacles which may interfere with the signal path.
• Inspect or replace the batteries.

For your convenience, the following list of terms is provided to help you understand the CD-i Player and its operation.

ACTION BUTTON – Two keys on the pointing device to perform actions or features.

AUDIO OUT – There are two jacks located on the back of your CD-i Player. They are used to send audio (sound) from the Player to either the TV, Stereo Receiver, or Amplifier. You could also hook it up to a VCR (Video Cassette Recorder) or Audio Cassette Recorder to record sound sent out from your Player.

CD, CD-DA, or CD-AUDIO – Terms used to describe a disc that produces only audio (sound) for your CD-i Player.

CD = Compact Disc

CD-DA = Compact Disc-Digital Audio

CD-Audio = Compact Disc Audio

DIGITAL VIDEO DISCS and VIDEO CD'S – These discs can only be played when a Digital Video cartridge is installed.

CD GRAPHICS – a technique for generating text, still pictures, or animated graphics that are related to the sound portion of the Compact Disc (CD).

CD-i – Compact Disc Interactive. A type of disc with both pictures and sound. Interacting with the disc allows you to tailor it to your taste.

CD-i PLAYER – Compact Disc Interactive Player. A device that allows you to play several types of discs, including CD-i, CD, Photo-CD and CD-ROM XA (Bridge).

CD-ROM-XA (Bridge) – One of several types of discs you can play in your CD-i Player.

CURSOR – Moving spot, controlled by your pointing device, shaped as an arrow or something else according the program you are playing, to guide you across the screen.

FEATURE – A task the CD-i Player can perform. For example, the Dim feature of the Player will dim your TV screen if it is selected.

FTS – Favorite Track Selection.

ICON – a display on one of the CD-i shell screens. The icon shows where to place the arrow. Press on one of the ACTION buttons to begin that feature. Example: "PLAY CD-i ►" on the CD-i screen. Place the arrow on top of the "►" and click on one of the ACTION buttons and the CD-i starts playing.

MODE – The operating condition or status of the CD-i Player. This is determined by the function currently engaged and/or the setting selected. For example, "Play mode".

PAUSE – Temporarily stopping play of a CD-Audio. When in the Play mode, press the PAUSE button to put the CD-i Player in the Pause mode.

PHOTO-CD – A type of compact disc on which photographs have been stored.

PLAY – The act of the Player taking the picture and/or sound from a disc and sending it to your TV and/or Stereo Receiver or Amplifier. You must press the PLAY button or select the PLAY icon before the Player will start reading a disc.

RF COAXIAL CABLE – Black, insulated, round cable used to connect the RF-modulator to the TV antenna input.

RF MODULATOR – Converts the audio and video output signal of the CD-i player to a RF-signal which can be fed into your TV's antenna input.

SCREENS – Word used when discussing with your TV. For example, "TV screen" refers to the area on the TV for viewing pictures. Word also used when discussing CD-i Player display screens. For example, the "CD-i Player Start-Up screen." These screens allow you to select functions you want the Player to perform.

STOP – Ending play of a disc. When in the Play mode, press the STOP button to end play of a CD-Audio.

THUMBPAD – The part of the pointing device used to guide the arrow across the screen. Place the arrow on top of the icon of a feature you want to perform.

TRACKS – Disc sections varying in length. There can be many tracks on one disc, with each track a distinct unit. Tracks are important in using the Scan and Shuffle features.

VIDEO OUT – There is one jack on the back of your CD-i Player that can be used to send pictures (video) to your TV. You could also hook it to a VCR (Video Cassette Recorder) to record pictures sent out from the Player.

VOLUME – The amount of sound you hear.

POINTING DEVICE – By pressing the buttons, signals are sent to the CD-i player to perform desired actions. For example PLAY.

NOTES

NOTES

SPECIFICATIONS

System
CD-Interactive

Usable discs

CD-i
CD-DA
PHOTO-CD
CD-i READY
CD BRIDGE
CD+GRAPHICS

Power requirement 120 V AC / 60 Hz

Power consumption
22W without (29W with Digital Video Cartridge 22ER9956)

Operating temperature
41°F(5°C) to 95°F(35°C)

Relative humidity
5% to 95% (no condensation)

Weight
With Digital Video Cartridge: 3.750 kg
Without Digital Video Cartridge: 3.500 kg

Dimensions (w x h x d)
420 mm x 90 mm x 286 mm
16.55" x 3.55" x 11.25"

Input

REAR
Input

(1 ports) 8-pin mini-DIN

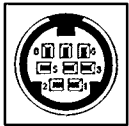

pin	signal	I/O
1	nc	-
2	rxd	I
3	txd	O
4	nc	-
5	ground	-
6	cts	I
7	rts	O
8	+5V (100 mA max)	

Input

FRONT
input

(1 ports) 8-pin mini-DIN

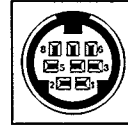

pin	signal	I/O
1	rxd1	I
2	rxd2	I
3	tx2	O
4	rts1	O
5	ground	-
6	nc	-
7	rts2	O
8	+5V (100 mA max)	

Output

Audio 2 Vrms
2 channel individual RCA pin cinch sockets

video (PAL) 1 Vpp (75 Ohm load, sync neg) RCA pin jack

Note: Pointing device speed of 1200 baud is supported.

Designs and specifications are subject to change without notice.

ACCESSORIES • ACCESSOIRES

SUPPLIED ACCESSORIES • ACCESSOIRES FOURNIS

These accessories are provided to help you use or set-up your CD-i Player.

Ces accessoires sont fournis pour vous permettre d'utiliser ou d'installer votre lecteur de CD-i.

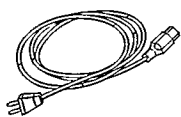

AC Cord
Cordon
d'alimentation

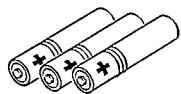

Three Batteries
Trois piles R6

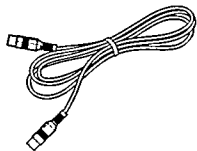

Antenna Cable *
(RF coaxial cable)
Câble d'antenne
(Câble RF)



"Thumbpad"
Remote Control
Handset
Télécommande à
manette

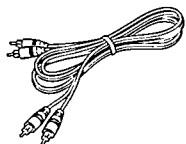

Audio L-R Cable
Double câble
audio stéréo

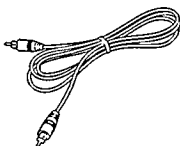

Video (CVBS)
Cable
Câble vidéo
(CVBS)

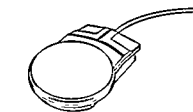

CD-i Mouse
Souris CD-i
22ER9011



Roller Controller
Boule de
commande
22ER9012

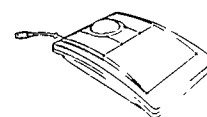

CD-i Trackball
Trackball pour CD-i
22ER9013



Touchpad
Manette de jeux
22ER9017



Gamepad
Clavier de jeux
22ER9021



Digital Video
Cartridge
Digital Vidéo
Cartridge
22ER9956

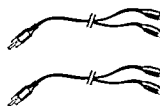

Audio Stereo
Splitter
Doubleur pour
Audio Stéréo
22ER9209

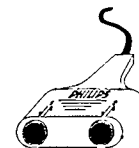

I/O Port Splitter for
2 devices
Doubleur pour
dispositif de
pointage pour 2
commandes
22ER9208

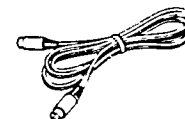

Y/C Cable
Câble Y/C
SBV1135A01

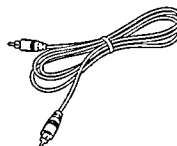

Digital out Cable
Câble dig.out
SBC1025

* available on some player versions only * disponible uniquement sur certains modèles de lecteurs

type no. of product • Numéro de série du produit

CDI 220

Date of purchase • Date d'achat

day • Jour month • Mois year • Année 19

The products and services described herein are not necessarily available in all countries.

©1995 PHILIPS INTERACTIVE MEDIA SYSTEMS

OPTIONAL ACCESSORIES • ACCESSOIRES EN OPTION

Maximize your pleasure with state-of-the-art accessories designed specifically for your CD-i Player.

The optional accessories shown here may be purchased from your supplier.

Augmentez votre plaisir grâce aux accessoires d'avant-garde spécialement conçus pour votre lecteur CD-i.

Les accessoires en option présentés ici peuvent être acquis auprès de votre revendeur.

Due to continuous product improvements this document is subject to change without notice

Printed in Belgium. 3104 125 21531

IB7396E001